

Beam Lines in 1996

Masao Kamada

UVSOR Facility, Institute for Molecular Science

In 1996, sixteen beam lines were operational. The open beam lines (1B, 2B1, 3A1, 3A2, 5B, 6A1, 7A, 8A, and 8B1) were used by 105 outside groups and 41 users in IMS. The in-house beam lines (1A, 2A, 3B, 4B, 6A2, 6B, and 8B2) were used by the groups in IMS and 24 outside groups. The joint programs consisted of 3 special projects, 24 cooperative researches, and 146 facility uses were conducted. The number of users was about 600 including scientists from foreign countries.

The beam lines of UVSOR are on the way to renewal. The upgrade proposals of the beam lines have been discussed on the UVSOR Workshops. About one third of beamlines are being upgraded in recent years. A Seya-Namioka monochromator at BL 7B is under replacement by a normal-incidence monochromator to improve a resolving power and spectral range for solid state spectroscopy. Another Seya-Namioka monochromator was removed from BL2B2 and then a Dragon-type monochromator is under construction for gaseous experiments in VUV and EUV ranges. A multi-layer monochromator was constructed and is now under installation to BL 4A for photo-chemical reaction experiments. A glancing-incidence monochromator at BL 8B1 has been replaced by a 15 m SGM monochromator. This new monochromator having a resolving power of 4,000 at 400 eV is used for solid and gaseous experiments in EUV region. A Bruker FT-IR interferometer has been installed to BL 6A1 besides the old FT-FIR of a Martin-Puplett type, and then the improved system can cover the wide wavelength range from 1 μm to 3 mm. A new monochromator (SGM-TRAIN) has been constructed at beamline 5A for the use of circularly polarized lights from the helical undulator.

Several trials with lots of efforts have been carried out in recent years to achieve new scientific and experimental findings. Combination experiments by use of laser and synchrotron radiation for pump-probe and double resonance is one of the research high lights in UVSOR in 1996. Laser-induced-fluorescence experiment was successfully carried out on ground-state alkali atoms desorbed from SR-irradiated potassium halide surfaces at BL 3A1. The SR-photon ionization of Iodine atoms produced by laser photodissociation of Methyl Iodide molecules was observed with the combination of Ti-sapphire laser and undulator radiation at BL 3A2. The two-photon experiment by using both of SR and Laser was also succeeded on BaF2 at BL 1B. New experiments with an electron-ion coincidence (EICO) method showed lots of fruitful data about SR-induced desorptions at BL 2B1.

A high-sensitive detection system consisting of a conventional analyzing monochromator and a CCD detector has been available at BL 1B to observe luminescence in organic and inorganic materials including halides, fullerenes, and oxides. Interesting subjects such as photo-chemical reaction experiments on Si, Diamond, and halides, soft x-ray microscopy on biospecimens, and incoherent photon-echo experiment have been successfully carried out at a free-port BL 8A. The photoelectron spectroscopy combined with SR is one of the powerful techniques to investigate electronic structures. Several kinds of photoelectron spectrometers are working or ready to work in UVSOR: High-performance electron analyzer SES-200 at soft x-ray beam line BL 1A, Two-dimensional spectrometer at VUV beamline BL 3B, An angle-resolved spectrometer at EUV beamlines BL 6A2 and 8B2, Photoelectron microscopy system at a wiggler beamline BL 7A, and A spin- and angle-resolved photoelectron spectrometer at helical undulator beamline BL 5A.

There were lots of troubles in 1996. The biggest one is the accidental air-leakage from the

differential pumping system at BL 8A to the storage ring. The other air-leakage accidents happened from a monochromator chamber to a first-mirror chamber at BL 8B1 and also from a sample chamber to a monochromator chamber at BL 7A. Therefore, **the UVSOR facility strongly asks all users to make sure of their experimental procedures according to the beam line manuals.**

A TOF tube, a sealing o-ring, and a beam line valve at BL 3A2 were replaced by the new ones in last autumn. The sample chamber at BL 1B was cleaned up to eliminate contamination due to unknown materials from the vacuum component. The first mirror at BL 8A was replaced by a new one too.

The persons who wish to use the open and in-house beam lines of UVSOR are recommended to contact with the following station master or supervisor and the representative, respectively.

Table I. Station masters and supervisors of open beam lines.

Beam Line	Station Master	Sub Master	Supervisor
1B	M. Hasumoto	S. Tanaka	M. Kamada
2B1	S. Tanaka	M. Kamada	M. Kamada
3A1	M. Kamada	M. Hasumoto	M. Kamada
3A2	E. Nakamura	T. Gejo	T. Kinoshita
5B	S. Kimura	H. Hasumoto	T. Kinoshita
6A1	S. Kimura	O. Matsudo	M. Kamada
7A	T. Kinoshita	O. Matsudo	T. Kinoshita
7B	T. Kinoshita	M. Hasumoto	T. Kinoshita
8A	E. Nakamura	T. Gejo	T. Kinoshita
8B1	T. Gejo	E. Nakamura	T. Kinoshita

Table II. Representatives of in-house beam lines.

Beam Line	Representative
1A	N. Kosugi
2A	T. Ibuki
2B2	K. Mitsuke
3B	K. Mitsuke
4A	T. Urisu
4B	T. Urisu
6A2	M. Kamada
6B	K. Yakushi
8B2	T. Ibuki

Open beam lines

	4/1	8	15	22	29	5/6	13	20	27	6/3	10	17	24	7/1	8	15	22	29	8/5	12	19	26	9/2	9	16	23	30	
1 B						Naka, Suzu, Kan', Ohni														Tani, guchi								
2B1						Seki, tani, Ouchi, Mase																						
3A1						Shida,																						
3A2						Mitsu, ke																						
5 B						Tune, a																						
6A1						Ikeza, Nan, ba																						
7 A						H.Yo, Matsu, Kita, Tana, ka																						
7 B																												
8 A						Umen o, Goto,																						
8B1						Kihar, a, Hiray, a																						
Machine	shut down						4T wiggler							single						machine line study								

Open beam lines

	9/30	10/7	14	21	28	11/4	11	18	25	12/2	9	16	23	30	1/6	13	20	27	2/3	10	17	24	3/3	10	17	24	31	
1 B						Suzu, Ohni, Kan', no																						
2B1						Kimu, ra, Naga, sono																						
3A1						Ohas, hi, Yosh, ida																						
3A2						Gejo, Koya, no																						
5 B						Toya, Fukui, Kimu, Kino																						
6A1						Nanb, a, Oka, mura																						
7 A						Kino, S.Yo, Hatto, Hase																						
7 B																												
8 A						Ogaw, a, Ume, no																						
8B1						Ibuki, Wata, Tabe																						
Machine	shut down	wiggler																										

In-house beam lines

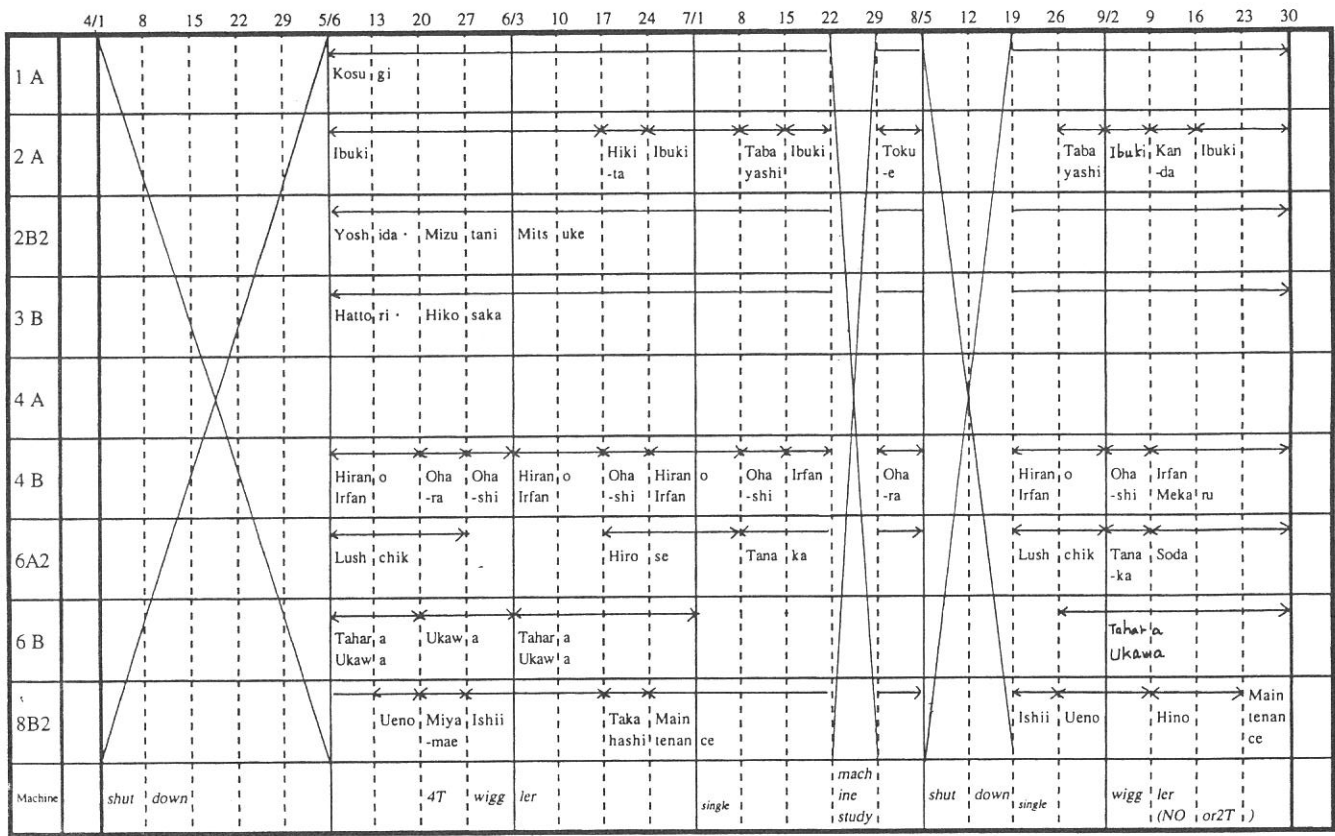

In-house beam lines

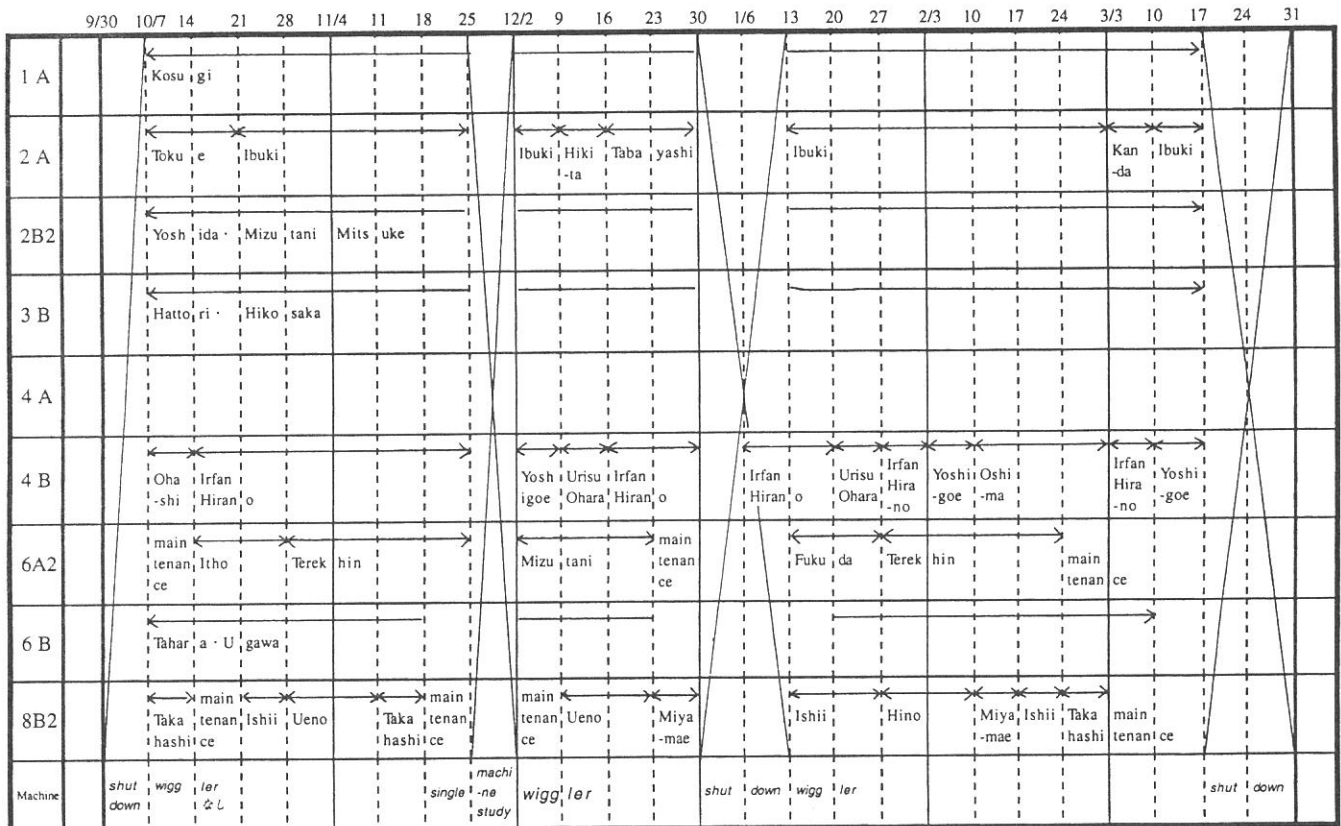

BL1A

Soft X-Ray Beamline for Photoelectron-Photoabsorption Spectroscopy

BL1A is a soft x-ray beamline for photoelectron-photoabsorption spectroscopy. The beamline is equipped with a focusing premirror and a double crystal monochromator[1]. The monochromator serves soft x-rays in the energy range from 585 to 4000 eV by using several kind of crystals such as β -alumina, beryl, quartz, InSb and Si crystals. The throughput spectra of the beryl (10 $\bar{1}$ 0) and InSb (111) crystals are shown in Fig.1. Typical energy resolution ($E/\Delta E_{hv}$) of the monochromator is about 1500 when we use a pair of beryl or InSb crystals.

For photoelectron-photoabsorption spectroscopy, an ultra-high-vacuum (UHV) apparatus is connected. The top view of the apparatus is shown in Fig 2. It is equipped with a high-performance electron analyzer (SES-200, SCIENTA Co.). The pass energy (E_p) can be varied between 1 and 500 eV and typical resolving power ($E_p/\Delta E_{elec.}$) is more than 1000. Using the apparatus, resonant photoelectron spectra for solid samples can be obtained with the total energy resolution (ΔE_{total}) of ~ 0.7 eV around $h\nu=1000$ eV.

Reference

[1] A.Hiraya et al., Rev. Sci. Instrum.,**63** (1992) 1264.

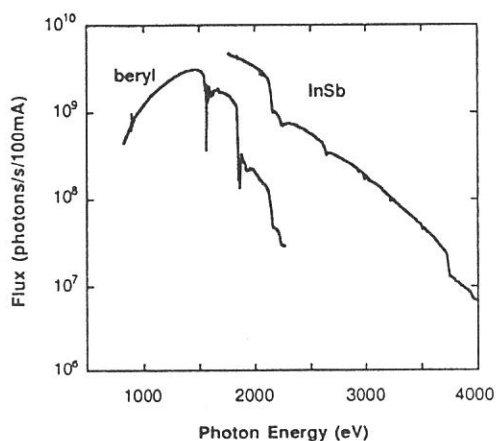

Figure 1. Throughput spectra of the double crystal monochromator at the BL1A.

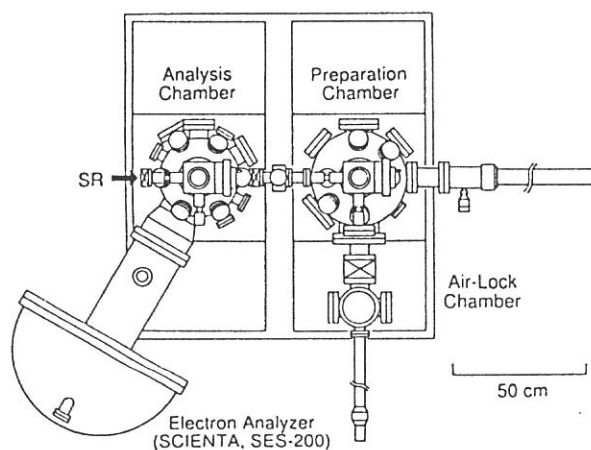

Figure 2. Top view of the UHV apparatus for photoemission-photoabsorption spectroscopy.

Specification

Monochromator	: double crystal monochromator ($\theta_B=70-20^\circ$)
Monochromator crystals	: β -alumina (22.53 \AA , 585-1609eV), beryl (15.965 \AA , 826-2271eV), (2d value, energy range) quartz (8.512 \AA , 1550-4000eV), InSb (7.481 \AA , 1764-4000eV), Si (6.271 \AA , 2104-4000eV)
Resolution	: $E/\Delta E=1500$ for beryl and InSb
Experiment	: photoelectron-photoabsorption spectroscopy for solid

BL1B

Seya-Namioka Monochromator for General Purpose in VUV Region

The beam line 1B has been used for many experiments such as absorption, reflectivity, photo-ionization, and luminescence in condensed phase. The system consists of a pre-mirror, a 1-m Seya-Namioka type monochromator, and a post-mirror. Three gratings with 600, 1200, and 2400 gr/mm can cover the wavelength range from 40 nm to 650 nm, and two post mirror make it possible to change the focus point. A long-focus mirror is usually used with a LiF window to separate a main chamber for spectroscopy in liquids and biospecimens, while a short-focus mirror is suited to solid-state spectroscopy. The output flux from this monochromator is about 10^{10} phs/s around 200 nm with 0.1 mm slits. The spectral distributions obtained with three gratings are shown in the figure, although they are not the best data because of the contamination of the mirrors and gratings due to the recent careless accident.

A second monochromator (Spex 270M) and a LN-cooled CCD detector (Princeton Inc.) are available for luminescence experiments, together with a liquid helium-flow type cryostat. A time-resolved system to observe luminescence and excitation spectra with three time-gates is also possible. The decay measurement is one of the highlights of this station. A couple of weeks are supplied for the decay measurements under single bunch operation. A TAC system is therefore one of the standard instruments at this beam line.

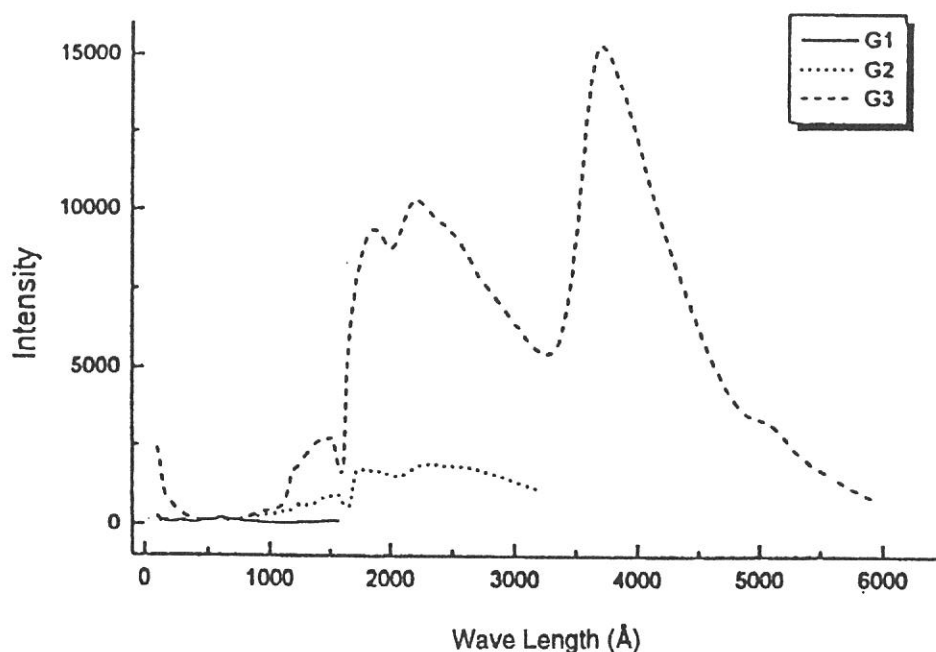

Gas Phase Photoabsorption and Fluorescence Spectroscopy

Photoabsorption cross section and fluorescence excitation spectra of gaseous sample are simultaneously measured in a vacuum cell or effusive jet condition. The primary photons in the 30-400 nm region are dispersed by a 1-m Seya monochromator. Higher order light in the 80-120 nm range is suppressed by using a long channel with a cross section $2.5 \times 5.0 \times 170$ mm long filled with argon gas at a pressure ≈ 0.3 Torr as shown in fig. 1. No filter is used between 30 and 80 nm since the photon flux at $\lambda < 40$ nm is very weak (see fig. 1). The gas filter and cell are placed in a main chamber which is evacuated by a 5000 l/s diffusion pump (Varian, Model VHS10). A LiF window is used for the measurement at the $105 < \lambda < 210$ nm range as usual. Thus, the total photoabsorption cross section and fluorescence excitation spectra are available in the wide wavelength region 30-210 nm without or with little contamination by the higher order light.

Dispersed fluorescence and polarity of emission from the excited fragment are also measurable in addition to the total photoabsorption and emission cross sections. In the single bunch operation of synchrotron radiation with the period of 178 ns, a radiative life time can be measured.

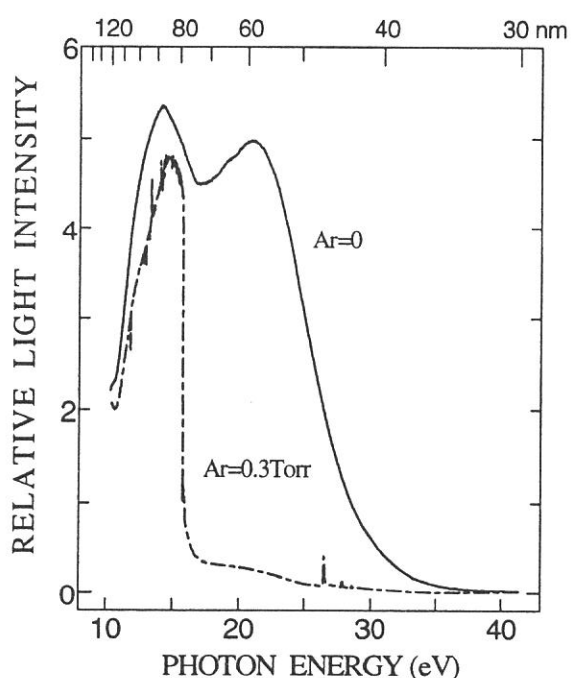

Fig. 1. Transmitted I_0 intensity with and without an Ar gas filter.

Specification

- | |
|---|
| <p>Monochromator : 1-m Seya
 Wavelength range : 30-400 nm
 Resolution : $\Delta E/E \approx 10^{-3}$ at 100 nm
 Grating : 1200 l/mm blazed at 96 nm
 Experiments :</p> <ul style="list-style-type: none"> • Vacuum cell or effusive jet • Total photoabsorption cross section • Fluorescence cross section • Dispersed fluorescence • Radiative lifetime • Emission polarity |
|---|

BL2B1

Soft-X ray beamline for solids and solid surfaces

BL2B1 is a beamline in order to study solids and solid surfaces by the use of photoabsorption and photoelectron spectroscopy. A 2-meter grazing incidence monochromator ('Grasshopper' type, Mark XV; Baker Manufacturing Co.) is installed. A 2400 l/mm grating has been installed since April 1994, and was replaced by a 1800 l/mm grating at March 1997. The resolving power is better than 600 at C-K edge (about 290 eV). Figure 1 shows the photoelectron yield from the Au mesh (10%-transmission) located near the position of a sample by the use of the 2400l/mm grating. The dip around 300 eV is due to carbon contamination of optical elements.

The analyzing chamber is installed at the focusing point of the monochromized light. The pressure is less than 1×10^{-10} Torr. A double-pass CMA, a LEED optics, an ion-gun for sputtering, and a sample holder which can be cooled with liquid nitrogen and heated, etc. are equipped for the 'in-situ' measurements. The photoelectron spectroscopy including CIS (Constant initial state spectroscopy), CFS (Constant final state spectroscopy) can be measured using CMA which is controlled by a personal computer. Samples can be transferred to the analyzing chamber from the air, through the preparation chamber in which sample treatments (e.g. cleaving, filing, and deposition) can be made.

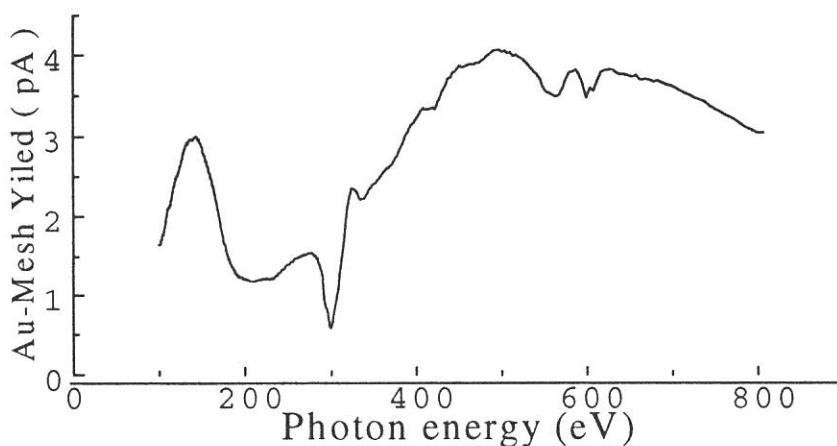

Figure 1. Photoelectron yield measured by the use of the Au mesh

Specification

Monochromator	:2m grasshopper type
Energy range	:95-1000 eV (2400 l/mm)
Resolution of photon	:<0.4eV at 300eV (2400 l/mm)
Resolution of photoelectron	:<0.3eV (hv=150eV)
Experiment	: Photoelectron spectroscopy, X-ray absorption spectroscopy,

BL3A1

Irradiation Port with Undulator Radiation

The beam line 3A1 has been used for various kinds of experiments need intense undulator radiation. In recent years, photo-desorption, photo-chemical reaction, SR-CVD, photo-etching, irradiation damage effects in condensed phase, light amplification induced by core-level excitation, and so on have been carried out at this beam line. The luminescence from High-Tc superconductors and fullerenes, the fluorescence yield of which is not high enough at beam lines for bending radiation, has been observed. A combination experiment with undulator radiation and a diode laser has been successfully conducted for time-response measurement of SR-induced desorption.

A planar-type undulator installed in a long straight section of the UVSOR storage ring provides an intense quasi-monochromatic radiation to beam lines 3A1 or 3A2. The undulator consists of 24 sets of magnets, a period length of which is 80 mm. The photon-energy range from 8 to 52 eV can be covered by the fundamentals with a K-value from 0.62 to 3.6, although higher harmonics are mixed into the spectral distribution in case of high K-values.

The beam line 3A1 has no monochromator between the undulator and a sample chamber. The radiation is introduced by a toroidal focusing mirror into sample chamber through a pinhole of 1 mm in diameter and metallic filter (Al, Sn, and In). A gold mesh is always installed in the sample chamber to monitor the incident photons. A typical spectrum distribution measured by the monochromator at BL 3A2 is shown in the figure, where the undulator gap is 60 mm and the photon flux is estimated to be about 10^{14} - 10^{15} phs/s on the samples.

A differential pumping system can be provided for the users who want to use gaseous materials. A second monochromator (Jobin-Yvon HR-320), another VUV monochromator (home-made one of normal-incident type), and a helium storage-type cryostat are available for luminescence experiments. A TAC system is also one of the standard instruments of this beam line. For liquid- or gaseous-phase experiments, MgF_2 windows can be installed to separate the sample chamber from the beam line.

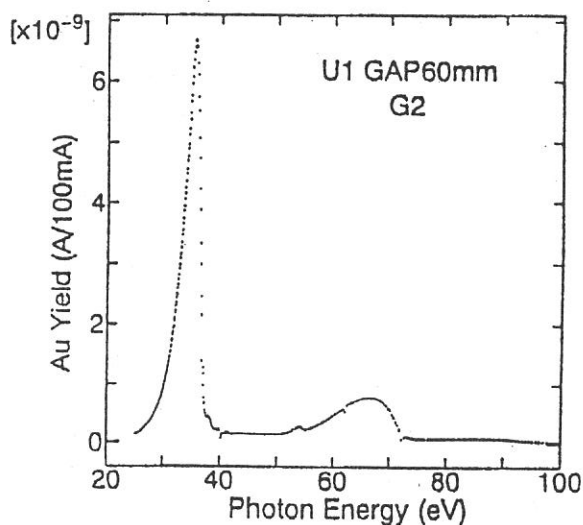

Fig. 2 Typical spectrum of undulator

BL3B

Beam Line for Gas Phase Two-Dimensional Photoelectron Spectroscopy

This beam line is devoted to studies of elementary atomic and molecular processes induced by excitation of valence electrons. A monochromator is a vertically dispersed normal incidence type with 3m focal length and 10° angle between the incident and diffracted photon beams. The maximum wavelength resolution of 0.007nm is narrow enough to separate vibrational levels of excited states for various molecules. The main component in an experimental chamber is a spherical sector electrostatic energy analyzer which has been designed and setup for photoelectron spectroscopy. In 1994, great improvement in detection efficiency for photoelectrons was realized by introducing a position sensitive detector. This allows us to perform two-dimensional photoelectron spectroscopy with good resolution ($\sim 30\text{meV}$) in which the photoelectron yield is measured as a function of both photon energy and electron kinetic energy (binding energy). A two-dimensional spectrum, usually represented as a contour plot (e.g. Fig. 1), contains rich information on photoionization dynamics and properties of superexcited states. A great variety of interesting high-lying states involved in autoionization have been studied as follows:

(1) the $(3\sigma_g)^{-1}(3\sigma_u)^1$ valence state of acetylene which dominates photoionization cross section and leads to strong vibrational excitation,¹⁾ (2) a bound valence state of nitric oxide whose autoionization gives rise to a number of irregularly spaced peaks in its photoionization efficiency curve,²⁾ (3) Rydberg states of nitric oxide which undergo dissociation into $\text{N}^{**} + \text{O}(^1D^e, ^3P^e)$ followed by autoionizing transitions of the superexcited nitrogen atoms.³⁾

1) H. Hattori and K. Mitsuke, *J. Electron Spectrosc. Rel. Phenom.* **80**, 1 (1996); H. Hattori *et al.*, *J. Chem. Phys.*, in press.

2) K. Mitsuke *et al.*, *J. Electron Spectrosc. Rel. Phenom.* **79**, 395 (1996).

3) Y. Hikosaka *et al.*, *J. Chem. Phys.* **105**, 6367 (1996).

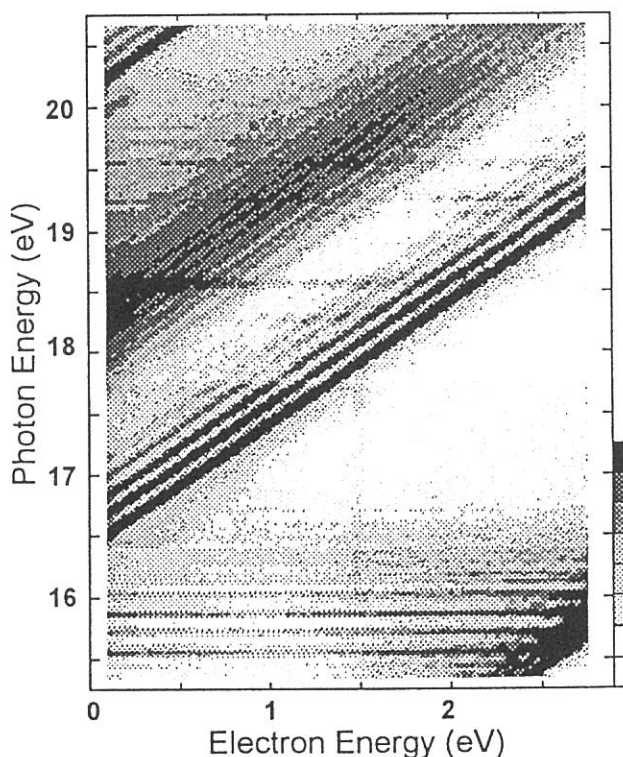

Figure 1. Two-dimensional photoelectron spectrum of N_2O taken at the photon energy range from 15.35 to 20.65eV. The electron yield is presented by the plots with eight tones from light to dark on a logarithmic scale.

Specification

Monochromator : 3 m normal incidence

Wavelength range : 30 - 200 nm

Resolution : 0.007 nm at 100 nm

BL3A2

Gas-Phase Dissociative Photoionization Apparatus

This machine has been constructed to study the formation of multiply-charged ions and their dissociation processes. The monochromator is constant-deviation grazing-incidence type with 2.2m focal length and covers wide wavelength region(10-100nm) where many kinds of molecules and multiply-charged ions are effectively measured. High intensity photon beam is available by introducing the radiation emitted from the undulator to the monochromator. The apparatus contains an angle-resolved time-of-flight mass spectrometer (TOFM) equipped with automatic data acquisition system for photoion-photoion coincidence measurements. For full understanding of dissociative multiple photoionization, we detect the coincidence signals of two fragment ions produced from a parent ion, evaluate the kinetic energy release in “Coulomb explosion”, and measure the angular distributions for the fragment ions. The sensitivity with respect to high-speed ions (several tens of electron volts) is much improved in comparison with commercial TOFMS.

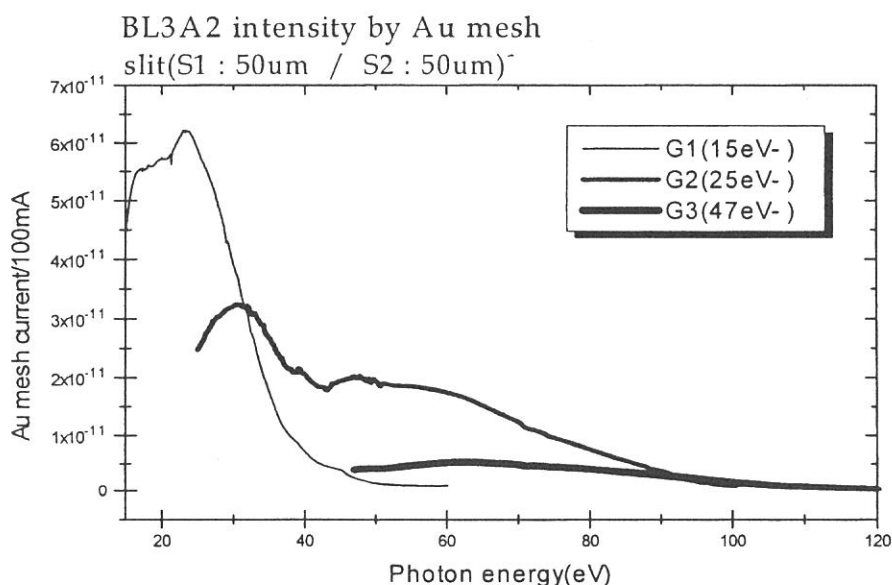

Specifications

monochromator	:	2.2m Constant-Deviation Grazing-incidence
Spectral range	:	10 - 100nm (15eV - 120eV)
Resolution	:	550 - 800 (0.03eV - 0.18eV)
Mass spectrometer	:	300
Length of the drift tube	:	0.2 - 1m
Rotatable angle	:	0 - 90° with respect to the photon beam

Multi-Layered Mirror Monochromator Beam Line for Synchrotron Radiation Stimulated Processing Study

This beam line is now under construction. Synchrotron radiation stimulated reaction has been studied actively during the last decade. The excitation energy dependence of the reaction, however, is a difficult data to obtain, due to that it requires a large number of monochromatised photons which is not supplied by the conventional monochromator beam lines. This beam line is designed to supply 10^{13} to 10^{14} monochromatised tunable photons/s with 3–5 % resolutions, by using a double crystal type multi-layered mirror monochromator. The multi-layered mirrors now considered are Mo/Si for 50–90 eV and Mo/C or Mo/B₄C for 90–150 eV ranges. The calculated reflectivities for a Mo/Si mirror is shown in Fig. 1. The background photons of the lower energy region can be removed by a metal thin film filter. The beam spot size at the focussed point (sample surface in the reaction chamber) is about 2x3 mm². For the energy range of 200–500 eV which is covered by this beam line, however, the reflectivity of the multi-layered mirror is generally low, and development of the high efficiency mirror is required.

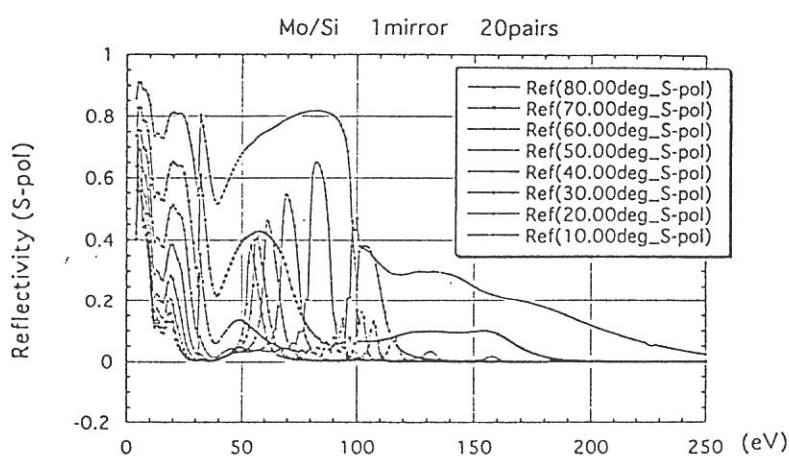

Fig. 1 Calculated reflectivities of the Mo/C multi-layered mirror.

Specifications

Monochromator	:Multi-layered mirror monochromator
Wavelength range	:50–150 eV
Resolution	:3–5 %
Experiments	:Excitation energy dependence of the SR processing

Synchrotron Radiation Stimulated Processing Beam Line

Several kinds of synchrotron radiation stimulated processing experiments can be conducted using this beam line. The reaction gases up to about 0.1 torr can be used by the differential vacuum pumping. Reaction apparatus shown in Fig. 1 is consisted of four ultra high vacuum chambers, which is used for etching and chemical vapor deposition (CVD) experiments, Si gas source molecular beam epitaxy (MBE) experiments, sample storage, and air-locked sample introduction. The infrared reflection absorption spectrum measurement system is equipped to the reaction chambers to monitor the surface reaction *in situ*. The SR stimulated chemical reaction of surface submonolayer hydrogen on Si(100) have been successfully monitored recently [1].

- [1] A.Yoshigoe, K.Mase, Y Tsusaka,
T.Urisu, Y.Kobayashi, and
T.Ogino, Appl. Phys. Lett. 67
(1995) 2364.

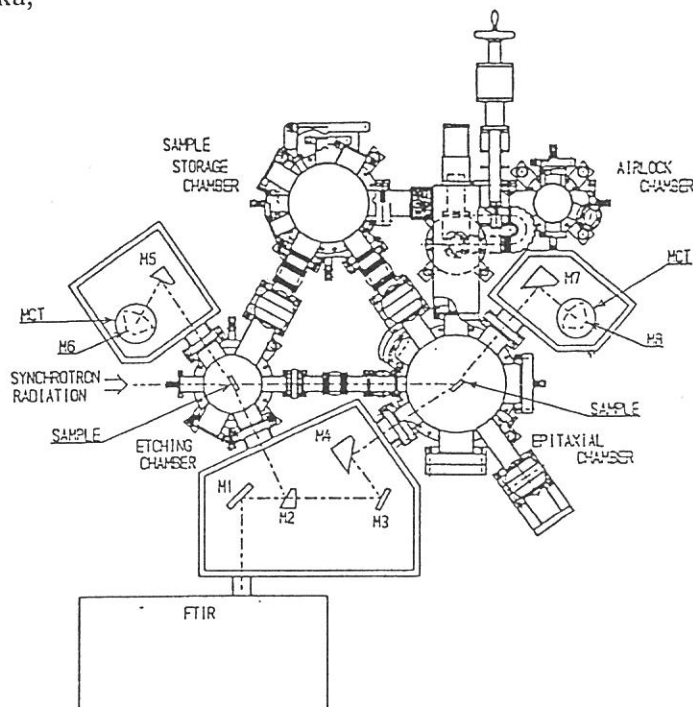

Figure 1. Reaction apparatus

Specification

- Monochromater : white beam reflected by bent-cylindrical mirror with grazing incidence angle of 2 degrees.
Wavelength range : 1-100nm
Experiments : SR-stimulated processing

BL5B

Calibration Apparatus of Optical Elements

BL5B has been constructed to calibrate optical elements. The beam line consists of a plane grating monochromator (PGM) and three chambers (Fig. 1). The chamber A is used for calibration of optical elements, the chamber B for optical measurements of solids and the chamber C for photo-stimulated desorption (PSD) experiments. The chamber C is sometimes changed to a chamber for photoemission microscopy.

The calibration chamber is equipped with a goniometer. The goniometer, which was installed for the characterization of optical components, has six degrees of freedom; X-Y translation of a sample, and interchange of samples and filters. They are driven by vacuum pulse motors. Since the polarization of SR is essential for such measurement, axis of the rotation can be made in either horizontal or vertical direction (s- or p-polarization).

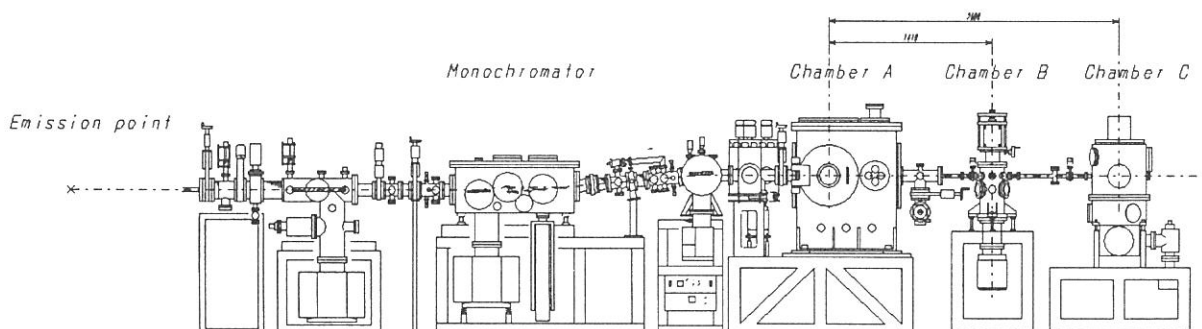

Figure 1. Schematic figure of BL5B spectrometer system.

Specification

Monochromator: Plane grating

Wavelength range: 2 - 200 nm (Fig. 2)

Resolution: $\lambda / \Delta\lambda = 300 \sim 500$

Experiments: Calibration of optical elements, absorption of solids, photo-stimulated desorption from rare gas solids, photoelectron microscopy.

Figure 2. Throughput spectra of BL5B detected by a gold mesh (84% transmission).

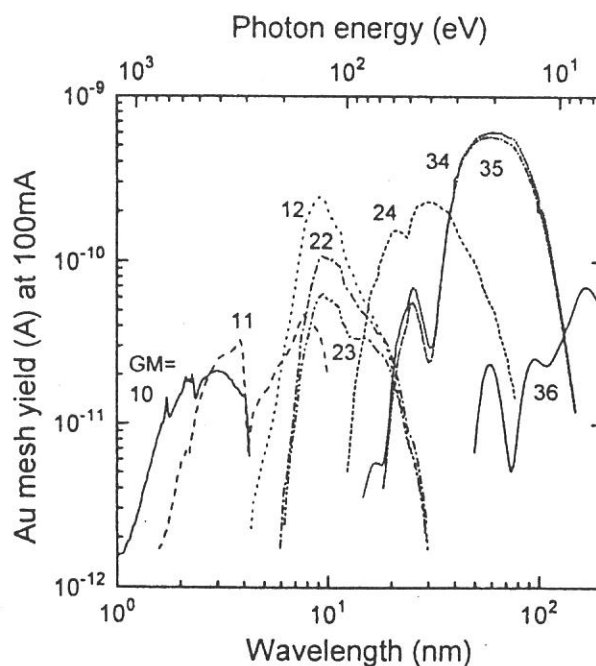

BL6A1

Fourier-Transform Middle- and Far-Infrared spectrometers for Solids

UVSOR covers very wide energy range from soft x-ray to millimeter wave. BL6A1 was constructed in order to cover a long wavelength part in the spectral distribution of UVSOR from near-infrared to millimeter wave. Beam line is composed of two kinds of interferometers, a Martin-Puplett type (SPECAC) and a rapid-scan type (Bruker).

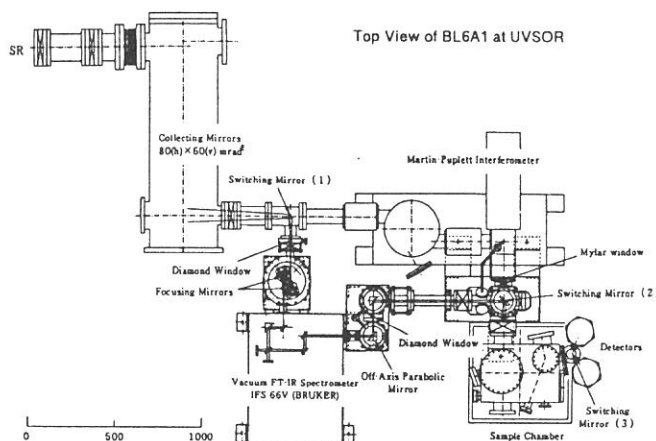

Figure 1. Top view of BL6A1.

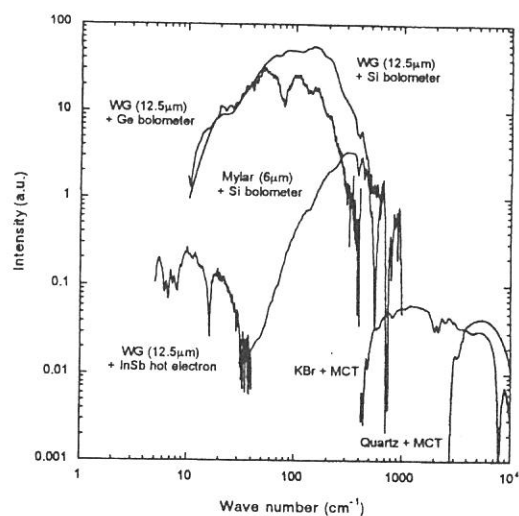

Figure 2. Throughput spectra of BL6A1.

Specification

Monochromator: Martin-Puplett type and rapid-scan type interferometers

Detectors: Si bolometer (20 - 1000 cm^{-1})

Ge bolometer (with polyethylene window, 30 - 300 cm^{-1})

Ge bolometer (with quartz window, 10 - 200 cm^{-1})

InSb hotelectron bolometer (2 set, 5 - 50 cm^{-1})

MCT (400 - 10000 cm^{-1})

Photovoltaic type MCT (400 - 4000 cm^{-1} , time response: 10 nsec)

Wavelength range: 0.5 mm - 33 μm (5 - 300 cm^{-1}) by Martin-Puplett interferometer

20 - 1 μm (50 - 10000 cm^{-1}) by rapid-scan interferometer

Resolution: $\lambda / \Delta\lambda = 500 - 20000$

Experiments: Temperature dependence of reflectivity and transmission spectra, absorption under high pressure (up to 20 GPa), reflectivity under magnetic field (up to 8 T), time-resolved spectroscopy.

BL6A2

Photoelectron Spectrometer for Solids and Surfaces

A Plane Grating Monochromator (PGM) consists of pre-mirrors, a plane grating, focusing mirror, and a post-mirror, with an exit slit only. It covers the wide spectral range from 2 to 130 eV with exchanging two gratings and 5 focusing mirrors. A typical spectral distribution is shown in the figure, where the numbering indicates the combination of the grating and the mirror. A typical photon flux is about 10^{11} phs/s/100 mA at 90 eV with a resolving power of 700. Angle-integrated and angle-resolved photoelectron spectrometers are available. The overall resolution of the integrated type analyzer is about 0.3 eV, while the angle-resolved hemispherical analyzer has a resolving power of 100 with an angular resolution of 1.1° in two axes. The optical system including an ICCD detector can be installed. The standard instruments for surface analysis such as Auger, LEED, Ion gun, and gas doser are installed in the analyzing chamber, the base pressure of which is 1.2×10^{-10} Torr. The samples are transferred from an air-lock chamber to the analyzing chamber through a preparation chamber.

Specifications

1) Monochromator

Type: Plane Grating Monochromator (no entrance slit)

Range: 2-130 eV

Resolution: 0.015-0.3 eV with slit of 0.3 mm

Flux: 10^{11} phs/s/100 mA at 90 eV with 0.1mm slit

2) Main Instruments

Angle-integrated Cylindrical Analyzer

(home made, $\Delta E=0.3$ eV)

Angle-Resolved Hemi-Spherical Analyzer

(home made, $E/\Delta E=100$ $\Delta\theta=1.1^\circ$ Two-axes)

Second Monochromator (Jobin-Yvon HR-320)

ICCD (Princeton Instrum.)

Preparation Chamber

Air-lock chamber for quick insertion

LEED of Reverse type (OMICRON)

Ion-gun of Differential type (ULVAC-Phi)

Auger (ULVAC-Phi)

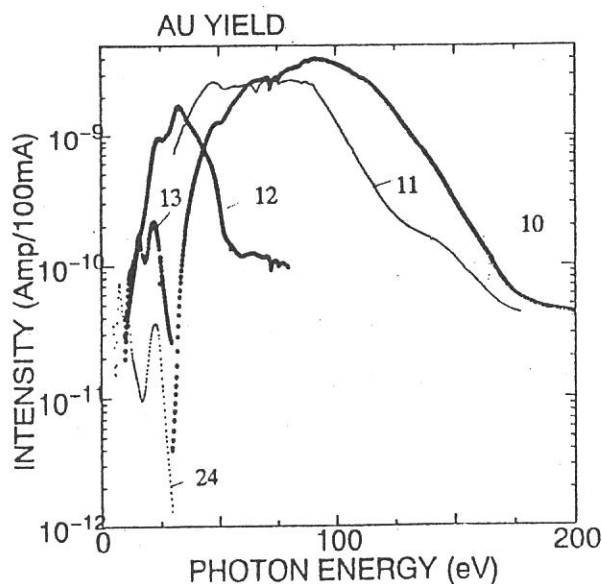

Fig. 1 Typical spectral distribution

BL6B

Fourier-Transformed Far-Infrared Spectrometer

BL6B has been designed to measure reflectance on small samples with high precision over FIR-IR regions. The optical system of BL6B consists of the following three parts: (1) beamline optics in ultrahigh vacuum (1×10^{-9} Torr), equipped with interchangeable four kinds of exit-window without breaking the vacuum, (2) adjusting optics between the beamline and a spectrometer, (3) a Bruker IFS-113v spectrometer, which offers automatic change of six beam-splitters under vacuum (~ 5 Torr). A reflectance unit is placed into a sample compartment of the spectrometer, also in the vacuum atmosphere. Temperature dependence can be traced with a LHe flow-type cryostat from room temperature down to 4 K. An infrared microscope is applied, if necessary, to obtain accurate reflectivity on samples smaller than millimeter size.

BL6B is specially suitable for the study of optical properties of organic conductors because available size of the crystals is usually very small. We are now investigating the electronic structure of organic conductors that have a single-particle gap appeared in far-infrared region, caused by SDW, CDW, or superconducting transition. The superconducting character is also discussed through the change of reflectivity versus the temperature around the T_c .

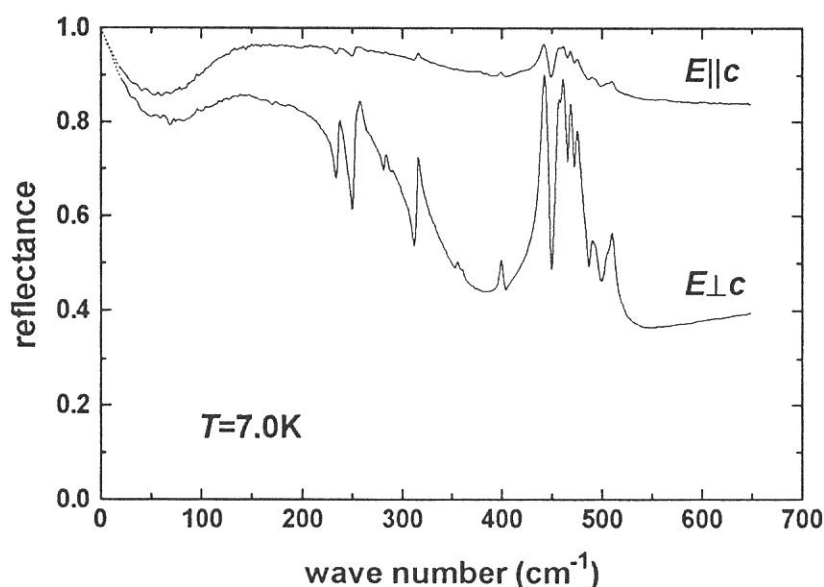

Figure 1. Polarized reflectance of β'' -(BEDT-TTF) $_2$ AuBr $_2$ measured at 7.0 K.

Specification

Interferometer	: Michelson type
Spectral range	: 6 - 10,000 cm^{-1}
Resolution	: better than 0.1 cm^{-1}
Experiment	: reflectance and transmittance of solid state

BL7A

Soft X-ray Spectrometer for Solids

The beam line BL7A equipped with a double crystal monochromator (DXM) was constructed for the spectroscopic research of solids in the soft X-ray region, where both the bending magnet and the 4T wiggler radiations are provided. The schematic drawings of the beam line and scanning mechanism of the double crystal monochromator are shown in Figure 1. When we use the relatively lower photon energy light (less than 1.7keV), we use the bending magnet line whereas the wiggler line is used for higher energy experiments. Recently, we have succeeded to measure soft X-ray spectra by using YB66 monochromator crystal, which is known to be one of the best monochromator crystals covering soft X-ray region from 1.1 to 2keV with higher performance. The detail of the use of YB66 is described in the part of the BL7A in this activity report.

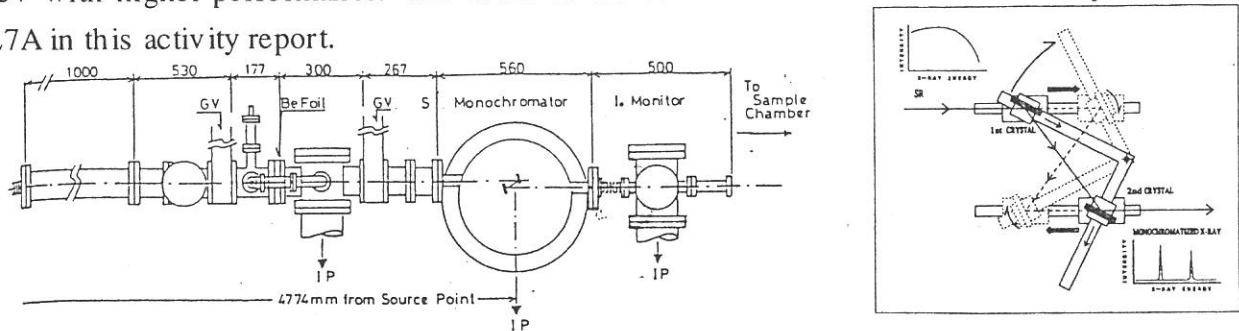

Figure 1. The schematic drawings of the beam line and scanning mechanism of the double crystal monochromator at the BL7A.

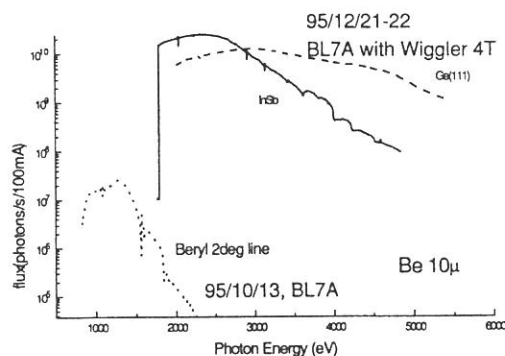

Figure 2. Throughput from the double crystal monochromator with typical monochromator crystal.

Specification

Monochromator : Double Crystal Monochromator

Monochromator crystals and covered photon energy:

β -Al₂O₃ (0.58-1.74keV), Beryl (0.82-2.27keV), YB66(400) (1.12-3.08keV),
Quartz-Y(1010) (1.53-4.26keV), InSb(111) (1.74-4.85keV), Ge(111) (2.00-5.55keV).

Typical resolution : 0.46eV (Beryl Crystal, E=860eV)

Experiments : X-ray absorption spectroscopy (by photoelectron total yield and/or fluorescence)

BL7B

3m Normal Incidence Monochromator for UV, VIS and IR Spectroscopy of Solids

The beamline BL7B is now under reconstruction. The 1m Seya-Namioka type monochromator is replaced to the 3m normal incidence monochromator (3m NIM; McPherson upgrade model of 2253) for the extended researches of the highest level with the higher resolution and intensity, the wider wave-length region available and so on. It will be also possible to utilize the linear and circular polarization inherent in synchrotron radiation (SR) and to realize some combined experimental systems, for example, with the synchronized laser to SR pulse or with the extended field. The outline of the new beamline is shown in Figure 1. The main parts of the system are a pre-mirror focusing system, a 3-m NIM and a post-mirror focusing system. The light from 50 to 1000 nm wavelength region is covered by changing three gratings *in situ*. Each spherical grating is original laminar type fabricated on SiO₂ and has effective grooved area of 120x40mm². The 2 focusing positions are available for the experiments. At the position between 2 positions, LiF or MgF₂ window valve is installed. Therefore, the measurements for the organic materials, liquid and biochemical ones are possible at the 2nd focal position.

After the final adjustment and test run, this beamline will be used for absorption, reflection and fluorescence measurements on various materials with higher performance (high energy resolution, high intensity, well-polarized light, short repetitive pulse light) not only in the VUV region but also in the near UV, VIS and near IR region.

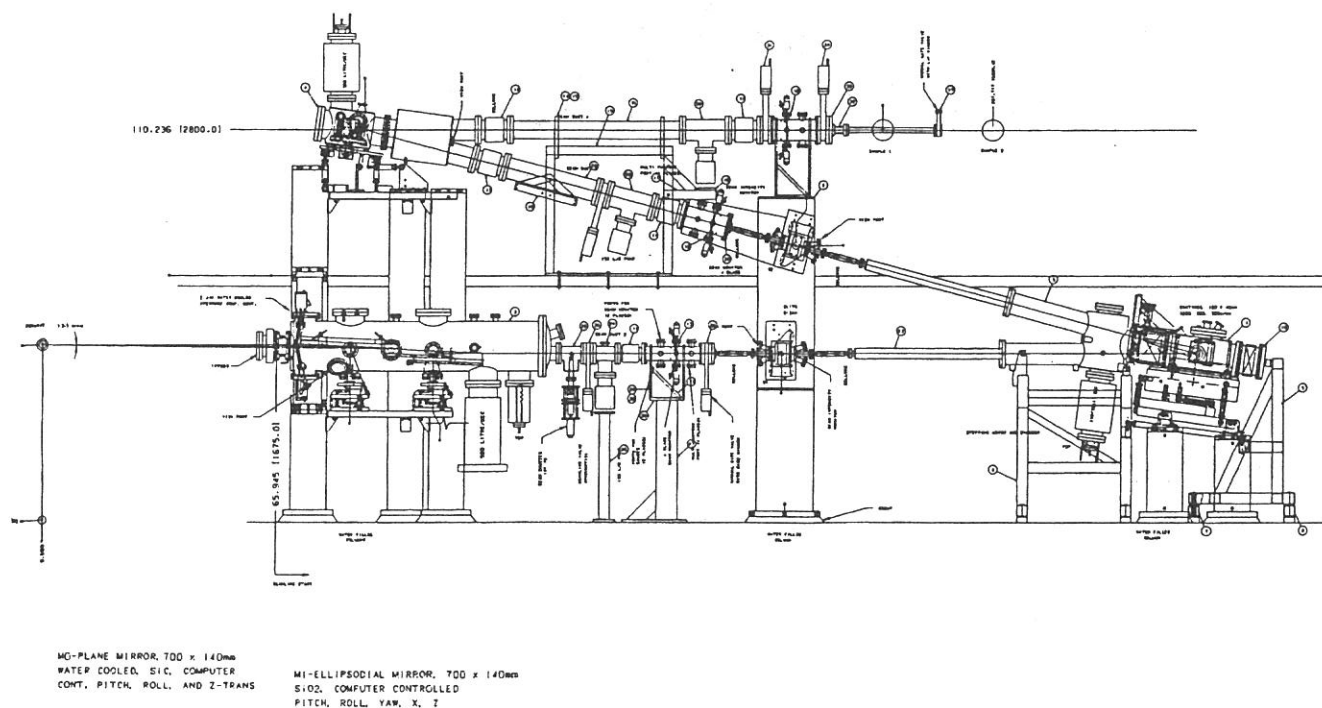

Figure 1. The outline of the side view of the new beamline BL7B.

Specification

Monochromator	: 3m Normal Incidence Monochromator
Wavelength range	: 50nm-1000nm
Typical resolution	: $E/\Delta E=4000-23000$ for 0.01mm slit
Experiments	: Absorption, reflection, fluorescence spectroscopy mainly for solids

BL8A

Free Port

This beamline was constructed as a free port to which user can connect their own instruments. The beamline consists of a front end, a focusing premirror chamber and a separation chamber. Both focused and unfocused beam can be used. A general purpose reaction chamber and a two (or three) stage differential pumping system are available for the experiments that use gas samples without window. With using three stage differential pumping system, gas pressure at the reaction chamber upto 0.5 torr can be used while keeping ultra high vacuum at the premirror chamber.

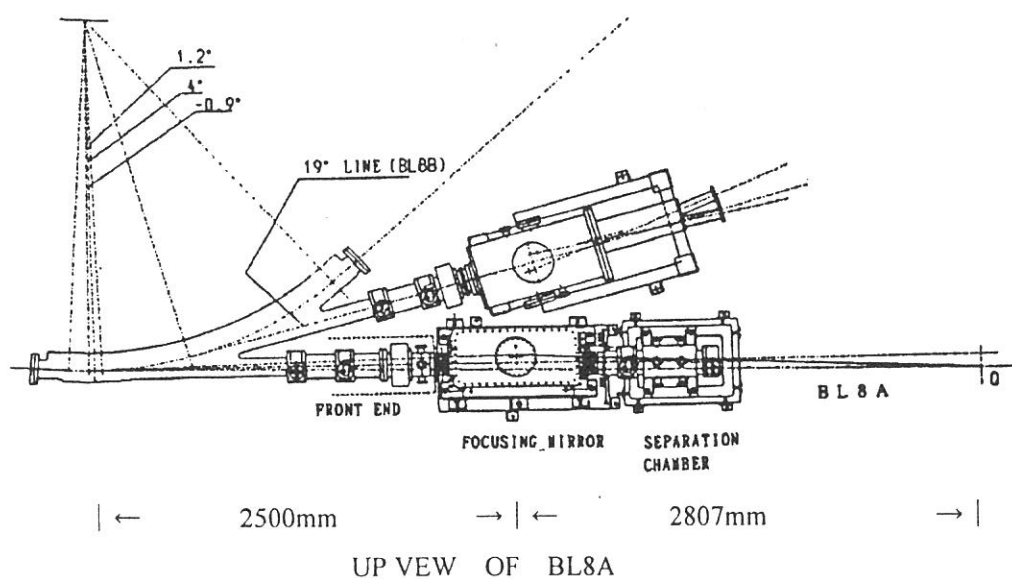

Specification

Spectral range : whole range of synchrotron radiation from UVSOR

Acceptance angle

Unfocused beam : 25 mrad (horizontal) × 8 mrad (vertical)
0.6 mrad (horizontal) × 0.6 mrad (vertical)
(with ϕ 3 mm aperture before sample)

Focused beam : 7.7 mrad (horizontal) × 8 mrad (vertical)
Beam spot size at focus : 3 mm (horizontal) × 2 mm (vertical)
Source - mirror distance : 2500 mm
Mirror - focus distance : 2807 mm

BL8B1

Photoabsorption and Photoionization Spectrometer

Last year a new beam line BL8B1 was constructed for observation of high resolution photoabsorption and photoionization experiments in the photon energy range from 30 to 800 eV, which includes the 1s core excitation energy of C, N and O atoms. For high resolution measurement among these energy, a constant-deviation constant-length spherical grating monochromator (CDCL-SGM) with three gratings (G1: R = 15 m; 1080 l/mm, G2: R = 15 m 540 l/mm, G3: R = 7.5 m; 360 l/mm) has been employed, whose entrance and exit slit positions and directions of incident and exit photon beams do not change during its scan. Consequently, it provides us with an resolution ($E/\Delta E$) of 4000 at 400 eV and of 3000 at 245 eV. A drain current of gold foil reveals the absolute photon flux normalized by an ring current when two slit widths are 10 μm (Fig. 1).

Being Equipped at the downstream of the mono - chrometer, an chamber with a time-of-flight ion detector and a photoelectron detector allows us to measure photoelectron - photoion coincidence (PEPICO) and photoion - photoion coincidence (PIPICO) spectra. Measurements of absorption, electron yield and emission spectra of solid samples are also available.

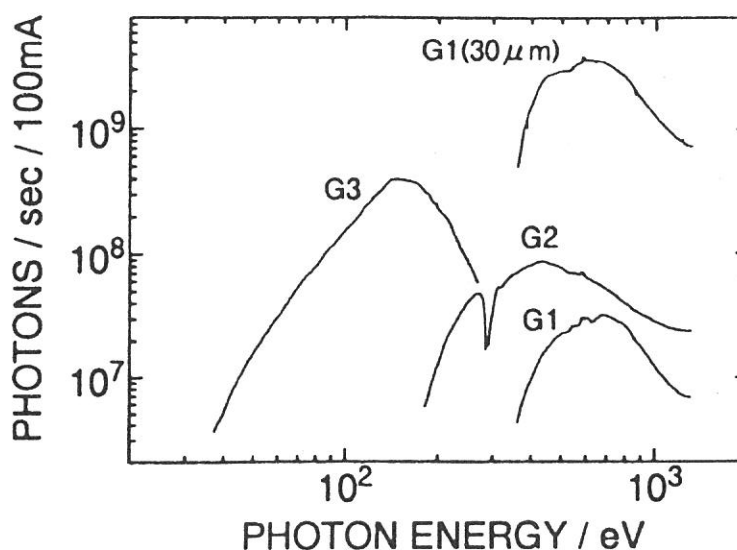

Figure 1. Absolute photon fluxes measured by a drain current of gold foil

Specification

Monochrometer	: 2.2 m constant-deviation grazing incidence
Wavelength range	: 30 to 800 eV
Resolution	: $E/\Delta E = 4000$ at 400 eV and 3000 at 245 eV
Available Experiments	: Measurement of photoabsorption and photoionization spectra for gas and solid sample

BL8B2

Angle-Resolved Ultraviolet Photoelectron Spectrometer for solids

BL8B2 is a beamline for angle-resolved ultraviolet photoemission spectroscopy (ARUPS) system which is designed for measuring various organic solid such as molecular crystals, organic semiconductor, and conducting polymers. The beamline consists of a plane-grating monochromator (PGM), a sample preparation chamber with a fast entry Load-Lock chamber, a measurement chamber with an accurate manipulator for temperature dependence (base pressure 3×10^{-10} Torr), a cleaning chamber (base pressure 2×10^{-10} Torr), and a sample evaporation chamber (base pressure 3×10^{-10} Torr). The cleaning chamber is equipped with back-view LEED/AUGER, Ar^+ gun and an infrared heating units. The PGM consists of pre-mirrors, a plane grating, focusing mirror, and a post-mirror, with an exit slit. It covers the wide range from 2 to 150 eV with exchanging two gratings (G1; 1200 l/mm, G2; 450 l/mm) and five cylindrical mirrors. The toroidal mirror focuses the divergent radiation onto the sample in the measurement chamber. The spot size of the zeroth-order visible light at the sample surface is about $1 \times 1 \text{ mm}^2$. The energy resolution at a slit width of $100 \mu\text{m}$ was found to be 0.004 - 0.3 eV in the wavelength range from 2 to 130 eV. A hemispherical electron energy analyzer of 25 mm mean radius with an angular resolution of 2° can be rotated around vertical and horizontal axes. The sample mounted on a manipulator can be also rotated around two axes.

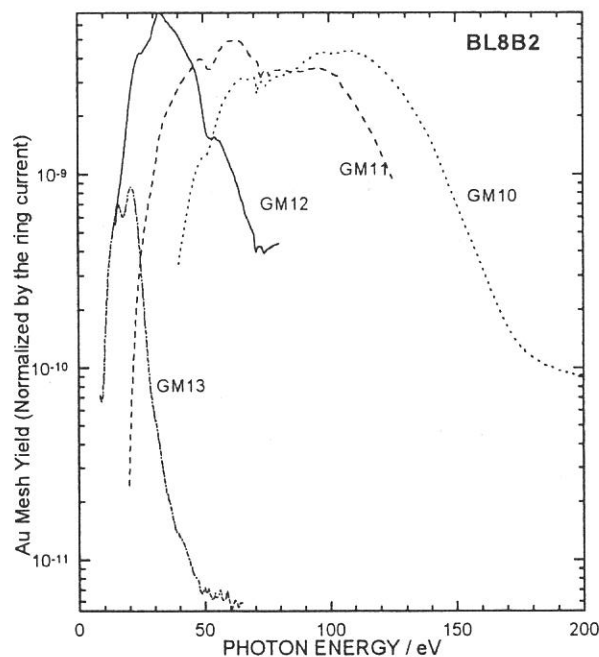

Figure Throughput spectra of plane-grating monochromator at BL8B2 with $100 \mu\text{m}$ exit slit.

Specification

Monochromator	: plane grating monochromator
Spectral range	: 2 - 130 eV
Resolution	: 0.25 eV at 40 eV, as determined by the Fermi edge of gold.
Experiment	: Ultraviolet Photoelectron Spectroscopy for various organic solids
Polarization	: 85~91 % at 5000 \AA